



**STANDARD FEATURES**

- Low weight cast aluminum construction.
- Quiet operation with integral inlet and outlet muffling.
- Recognized TEFC - **cURus** motor.
- High efficiency / low noise impeller design.
- No lubrication / maintenance required.
- Allowed ambient: +5 °F to +104 °F.
- Mountable in any plane.

**OPTIONS**

- Special voltages.
- Surface treatment or plating.
- Gas tight sealing.
- Special designs available.

**ACCESSORIES**

- Inlet and/or inline filters.
- Additional inlet/outlet silencers.
- Safety valves.
- Flow converting devices.
- Optionals connectors

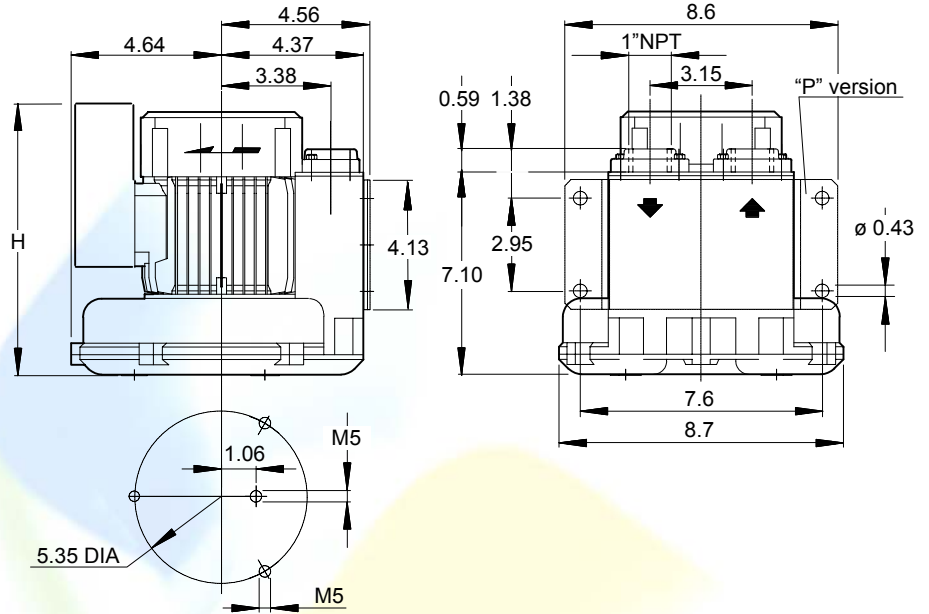

Dimensions in inches.  
 Dimension for reference only.

Model	Maximum flow Scfm		Installed power Hp		Maximum differential pressure $\Delta p$ ( In WG)		Noise level Lp dB (A) (1)		Overall dimensions H Inches	Weight Lbs
	60 Hz 3500 rpm	50 Hz 2900 rpm	60 Hz 3500 rpm	50 Hz 2900 rpm	60 Hz 3500 rpm	50 Hz 2900 rpm	60 Hz 3500 rpm	50 Hz 2900 rpm		
06	39	32	1/3	-	36	-	58.7	-	10.60	18.30
			1/2	1/2	52	36	59.0	58.0	10.60	18.50

(1) Noise measured at 1 m distance with inlet and outlet ports piped, in accordance to ISO 3744.

- For proper use, the blower should be equipped with inlet filter and safety valve; other accessories available on request.
- Ambient temperature from +5° to +104°F.
- Specifications subject to change without notice.

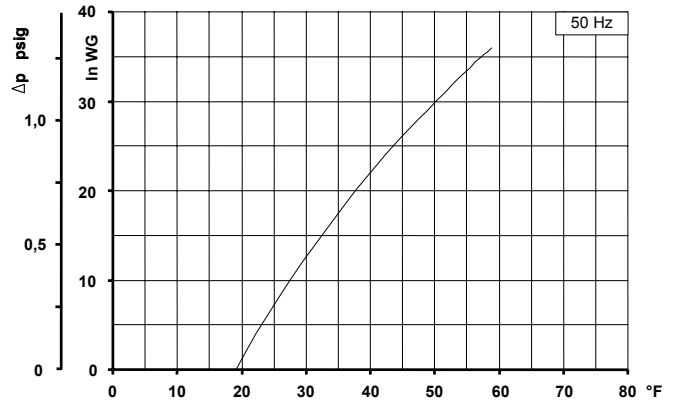
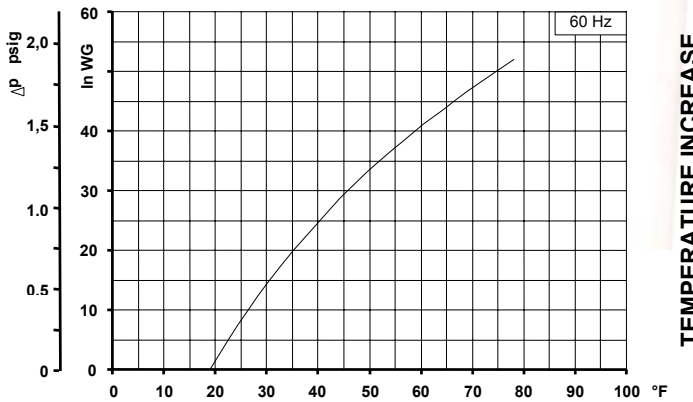
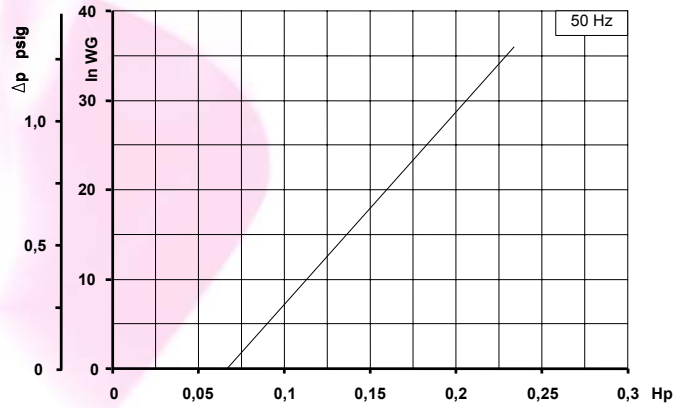
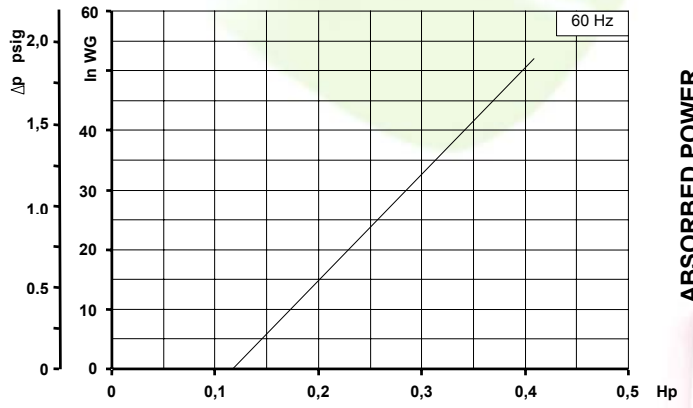
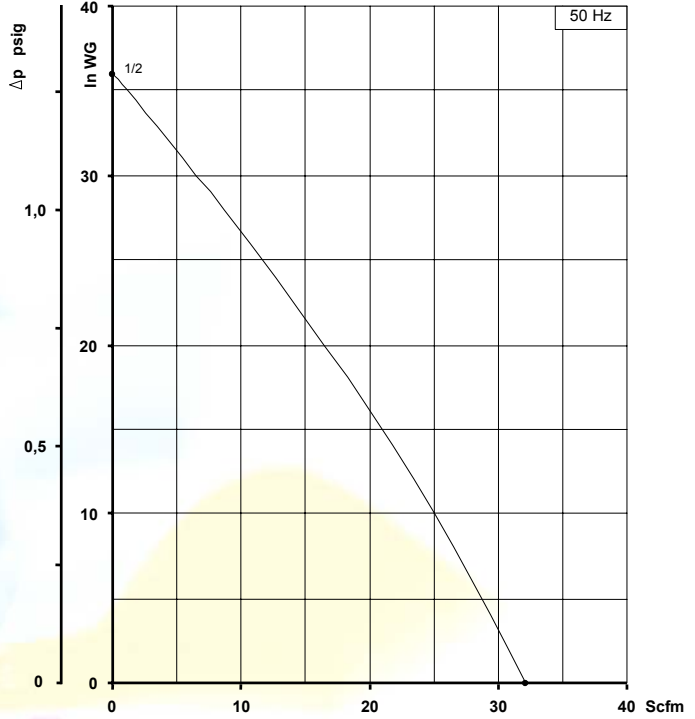
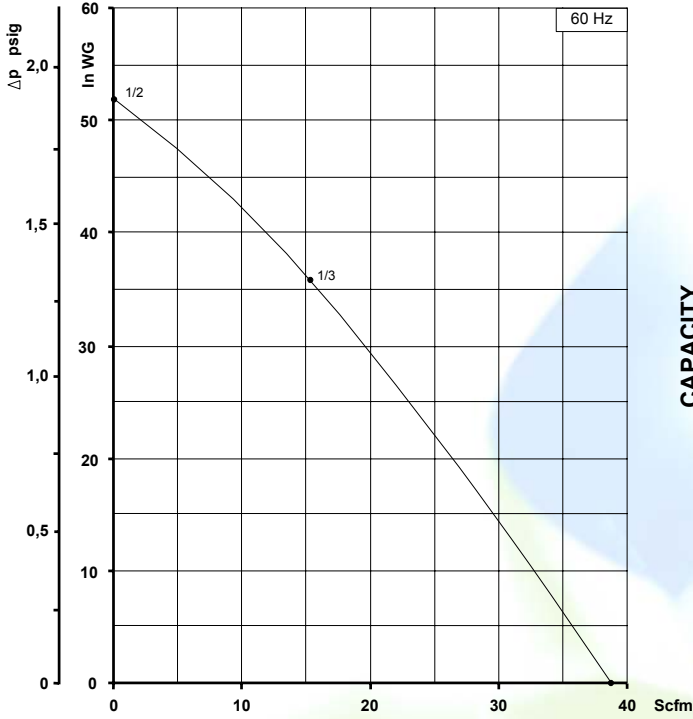

Curves refer to air at 68°F temperature and 29.92 In Hg atmospheric pressure (abs) measured at inlet port.  
 Values for flow, power consumption and temperature rise: +/-10% tolerance.  
 Data subject to change without notice.